

İKESIT A-A
ÖLÇEK 1 : 5

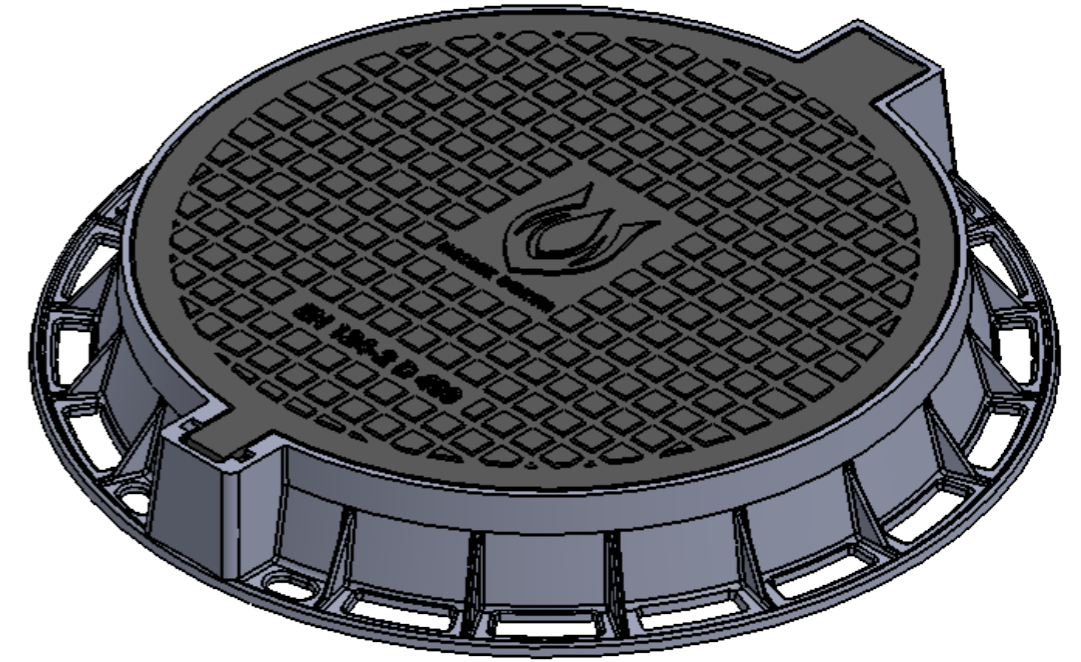
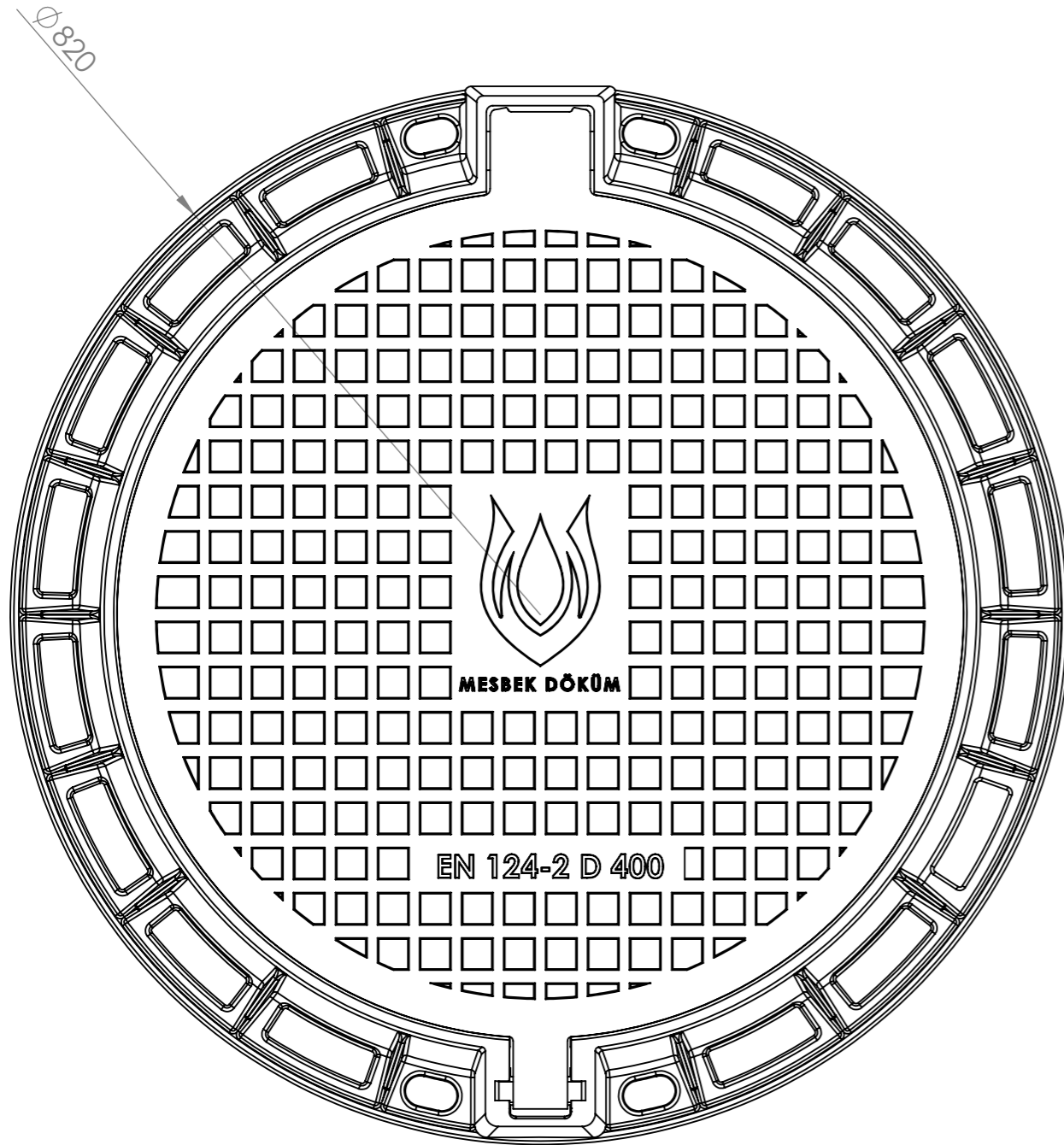
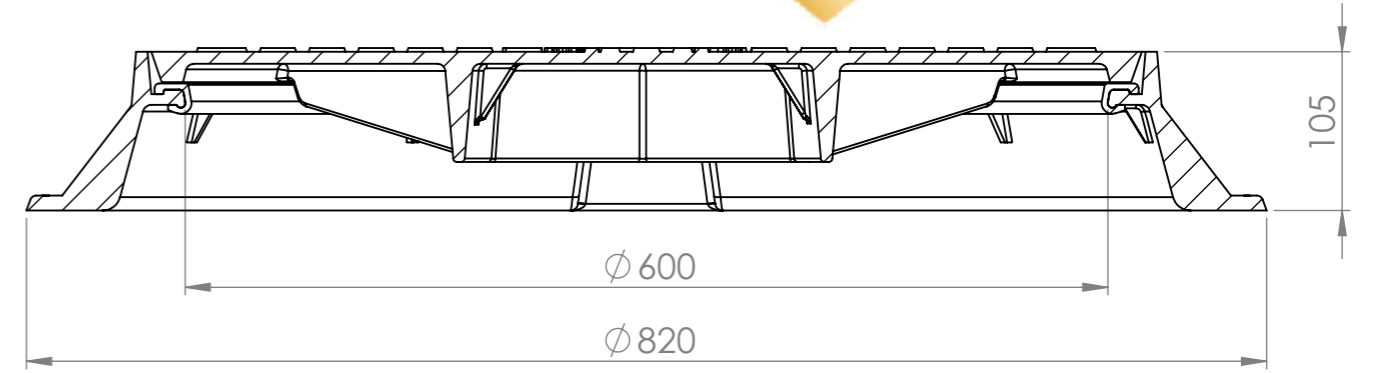
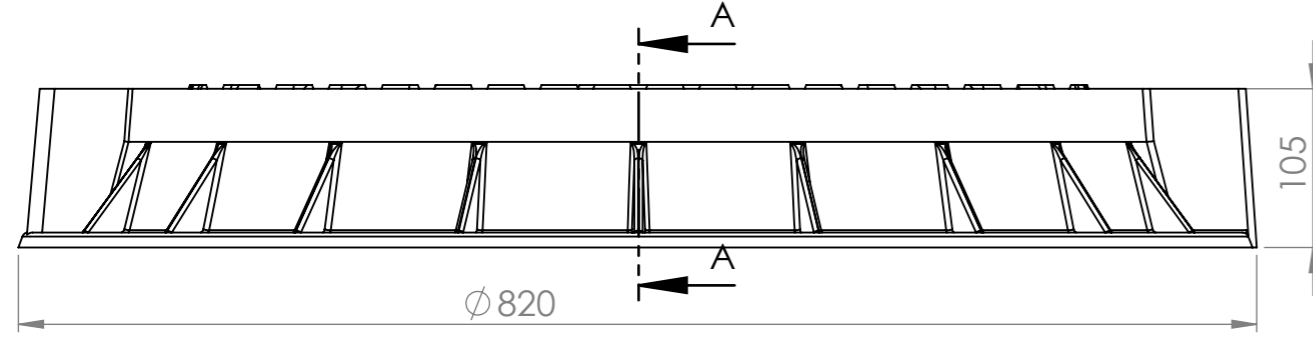

mesbek			
DESIGNER	M.DURSUN	PRODUCT NAME	
DESIGN DATE	19.10.2018	ORTA YÜK BACA KAPAĐI	
DESCRIPTION		PRODUCT CODE	MES 1035-3
		PROJECT CODE	
		CLASS	C 250
		STANDART	EN 124-2
REVISION		MATERIAL	GGG 50
REVISION DATE		WEIGHT	52kg±3